

LP2981

Micropower SOT, 100 mA Ultra Low-Dropout Regulator

General Description

The LP2981 is a 100 mA, fixed-output voltage regulator designed specifically to meet the requirements of battery-powered applications.

Using an optimized VIP™ (Vertically Integrated PNP) process, the LP2981 delivers unequalled performance in all specifications critical to battery-powered designs:

Dropout Voltage. Typically 200 mV @ 100 mA load, and 7 mV @ 1 mA load.

Ground Pin Current. Typically 600 μ A @ 100 mA load, and 80 μ A @ 1 mA load.

Sleep Mode. Less than 1 μ A quiescent current when ON/OFF pin is pulled low.

Smallest Possible Size. SOT-23 package uses an absolute minimum of board space.

Precision Output. 0.75% tolerance output voltages available (A grade).

5.0V, 3.3V, and 3.0V versions available as standard products.

Features

- Ultra low dropout voltage
- Output voltage accuracy 0.75% (A Grade)
- Guaranteed 100 mA output current
- Smallest possible size (SOT-23 Package)
- < 1 μ A quiescent current when shutdown
- Low ground pin current at all load currents
- High peak current capability (300 mA typical)
- Wide supply voltage range (16V max)
- Fast dynamic response to line and load
- Low Z_{OUT} over wide frequency range
- Overtemperature/overcurrent protection
- -40°C to +125°C junction temperature range

Applications

- Cellular Phone
- Palmtop/Laptop Computer
- Personal Digital Assistant (PDA)
- Camcorder, Personal Stereo, Camera

Block Diagram

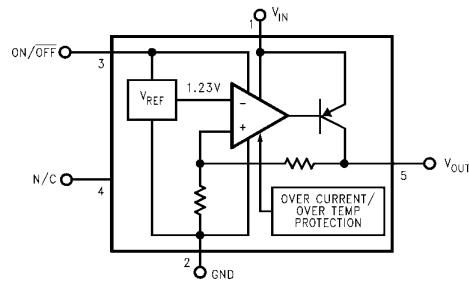

TL/H/12506-1

Connection Diagram and Ordering Information

5-Lead Small Outline Package (M5)

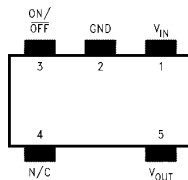

Top View

TL/H/12506-2



Actual Size

TL/H/12506-3

For Ordering Information See Table I in this Datasheet
See NS Package Number MA05A

VIP™ is a trademark of National Semiconductor Corporation.

Absolute Maximum Ratings (Note 1)

If Military/Aerospace specified devices are required, please contact the National Semiconductor Sales Office/Distributors for availability and specifications.

Storage Temperature Range	-65°C to +150°C
Operating Junction Temperature Range	-40°C to +125°C
Lead Temperature (Soldering, 5 sec.)	260°C
ESD Rating (Note 2)	2 kV
Power Dissipation (Note 3)	Internally Limited

Input Supply Voltage (Survival)	-0.3V to +16V
Input Supply Voltage (Operating)	2.1V to +16V
Shutdown Input Voltage (Survival)	-0.3V to +16V
Output Voltage (Survival, Note 4)	-0.3V to +9V
I _{OUT} (Survival)	Short Circuit Protected
Input-Output Voltage (Survival, Note 5)	-0.3V to +16V

Electrical Characteristics Limits in standard typeface are for T_J = 25°C, and limits in **boldface type** apply over the full operating temperature range. Unless otherwise specified: V_{IN} = V_{O(NOM)} + 1V, C_{IN} = 1 μF, I_L = 1 mA, C_{OUT} = 4.7 μF, V_{ON/OFF} = 2V.

Symbol	Parameter	Conditions	Typ	LP2981AI-XX (Note 6)		LP2981I-XX (Note 6)		Units
				Min	Max	Min	Max	
V _O	Output Voltage (5.0V Versions)	V _{IN} = V _{O(NOM)} + 1V	5.0	4.962	5.038	4.937	5.063	V
		1 mA < I _L < 100 mA	5.0	4.950 4.875	5.050 5.125	4.900 4.825	5.100 5.175	
	Output Voltage (3.3V Versions)	V _{IN} = V _{O(NOM)} + 1V	3.3	3.275	3.325	3.259	3.341	
		1 mA < I _L < 100 mA	3.3	3.267 3.217	3.333 3.383	3.234 3.184	3.366 3.416	
	Output Voltage (3.0V Versions)	V _{IN} = V _{O(NOM)} + 1V	3.0	2.977	3.023	2.962	3.038	
		1 mA < I _L < 100 mA	3.0	2.970 2.925	3.030 3.075	2.940 2.895	3.060 3.105	
$\frac{\Delta V_O}{\Delta V_{IN}}$	Output Voltage Line Regulation	V _{O(NOM)} + 1V ≤ V _{IN} ≤ 16V	0.007		0.014 0.032		0.014 0.032	%/V
V _{IN-V_O}	Dropout Voltage (Note 7)	I _L = 0	1		3 5		3 5	mV
		I _L = 1 mA	7		10 15		10 15	
		I _L = 25 mA	70		100 150		100 150	
		I _L = 100 mA	200		250 375		250 375	
I _{GND}	Ground Pin Current	I _L = 0	65		95 125		95 125	μA
		I _L = 1 mA	80		110 170		110 170	
		I _L = 25 mA	200		300 550		300 550	
		I _L = 100 mA	600		800 1500		800 1500	
		V _{ON/OFF} < 0.3V	0.01		0.8		0.8	
		V _{ON/OFF} < 0.15V	0.05		2		2	
V _{ON/OFF}	ON/OFF Input Voltage (Note 8)	High = O/P ON	1.4	2.0		2.0		V
		Low = O/P OFF	0.50		0.15		0.15	
I _{ON/OFF}	ON/OFF Input Current	V _{ON/OFF} = 0	0.01		-1		-1	μA
		V _{ON/OFF} = 5V	5		15		15	

Electrical Characteristics Limits in standard typeface are for $T_J = 25^\circ\text{C}$, and limits in **boldface type** apply over the full operating temperature range. Unless otherwise specified: $V_{IN} = V_{O(NOM)} + 1\text{V}$, $C_{IN} = 1\ \mu\text{F}$, $I_L = 1\ \text{mA}$, $C_{OUT} = 4.7\ \mu\text{F}$, $V_{ON/OFF} = 2\text{V}$. (Continued)

Symbol	Parameter	Conditions	Typ	LP2981AI-XX (Note 6)		LP2981I-XX (Note 6)		Units
				Min	Max	Min	Max	
$I_{O(PK)}$	Peak Output Current	$V_{OUT} \geq V_{O(NOM)} - 5\%$	400	150		150		mA
e_n	Output Noise Voltage (RMS)	BW = 300 Hz–50 kHz, $C_{OUT} = 10\ \mu\text{F}$	160					μV
$\frac{\Delta V_{OUT}}{\Delta V_{IN}}$	Ripple Rejection	$f = 1\ \text{kHz}$ $C_{OUT} = 10\ \mu\text{F}$	63					dB
$I_{O(MAX)}$	Short Circuit Current	$R_L = 0$ (Steady State) (Note 9)	150					mA

Note 1: Absolute maximum ratings indicate limits beyond which damage to the component may occur. Electrical specifications do not apply when operating the device outside of its rated operating conditions.

Note 2: The ESD rating of pins 3 and 4 is 1 kV.

Note 3: The maximum allowable power dissipation is a function of the maximum junction temperature, $T_{J(MAX)}$, the junction-to-ambient thermal resistance, θ_{JA} , and the ambient temperature, T_A . The maximum allowable power dissipation at any ambient temperature is calculated using:

$$P(\text{MAX}) = \frac{T_{J(\text{MAX})} - T_A}{\theta_{JA}}$$

The value of θ_{JA} for the SOT-23 package is 300°C/W . Exceeding the maximum allowable power dissipation will cause excessive die temperature, and the regulator will go into thermal shutdown.

Note 4: If used in a dual-supply system where the regulator load is returned to a negative supply, the LP2981 output must be diode-clamped to ground.

Note 5: The output PNP structure contains a diode between the V_{IN} and V_{OUT} terminals that is normally reverse-biased. Reversing the polarity from V_{IN} to V_{OUT} will turn on this diode (see Application Hints).

Note 6: Limits are 100% production tested at 25°C . Limits over the operating temperature range are guaranteed through correlation using Statistical Quality Control (SQC) methods. The limits are used to calculate National's Averaging Outgoing Level (AOQL).

Note 7: Dropout voltage is defined as the input to output differential at which the output voltage drops 100 mV below the value measured with a 1V differential.

Note 8: The ON/OFF inputs must be properly driven to prevent misoperation. For details, refer to Application Hints.

Note 9: See Typical Performance Characteristics curves.

Basic Application Circuit

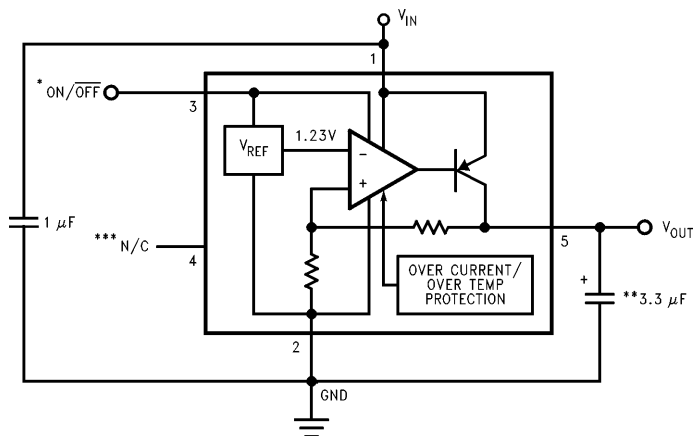

TL/H/12506-4

*ON/OFF input must be actively terminated. Tie to V_{IN} if this function is not to be used.

**Minimum Output Capacitance is shown to insure stability over full load current range. More capacitance provides superior dynamic performance and additional stability margin (see Application Hints).

***Do not make connections to this pin.

Ordering Information

TABLE I. Package Marking and Order Information

Output Voltage (V)	Grade	Order Information	Package Marking	Supplied as:
5.0	A	LP2981AIM5X-5.0	L03A	3k Units on Tape and Reel
5.0	A	LP2981AIM5-5.0	L03A	250 Units on Tape and Reel
5.0	STD	LP2981IM5X-5.0	L03B	3k Units on Tape and Reel
5.0	STD	LP2981IM5-5.0	L03B	250 Units on Tape and Reel
3.3	A	LP2981AIM5X-3.3	L04A	3k Units on Tape and Reel
3.3	A	LP2981AIM5-3.3	L04A	250 Units on Tape and Reel
3.3	STD	LP2981IM5X-3.3	L04B	3k Units on Tape and Reel
3.3	STD	LP2981IM5-3.3	L04B	250 Units on Tape and Reel
3.0	A	LP2981AIM5X-3.0	L05A	3k Units on Tape and Reel
3.0	A	LP2981AIM5-3.0	L05A	250 Units on Tape and Reel
3.0	STD	LP2981IM5X-3.0	L05B	3k Units on Tape and Reel
3.0	STD	LP2981IM5-3.0	L05B	250 Units on Tape and Reel

Connection Diagram

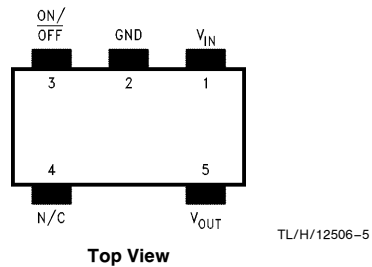

Top View

See NS Package Number MA05A

Typical Performance Characteristics

Unless otherwise specified: $T_A = 25^\circ\text{C}$, $V_{IN} = V_{O(NOM)} + 1\text{V}$, $C_{OUT} = 4.7\ \mu\text{F}$, $C_{IN} = 1\ \mu\text{F}$ all voltage options, ON/OFF pin tied to V_{IN} .

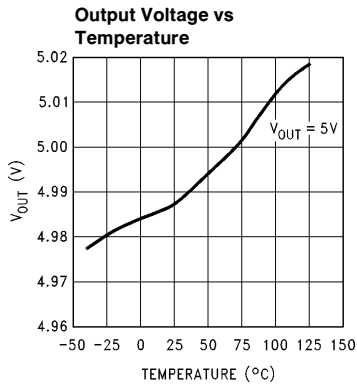

TL/H/12506-6

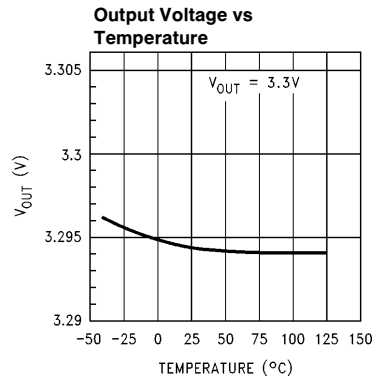

TL/H/12506-7

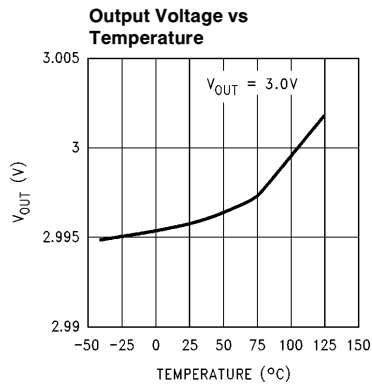

TL/H/12506-8

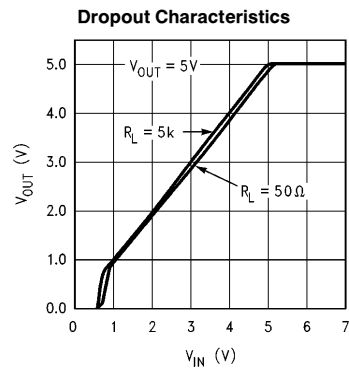

TL/H/12506-9

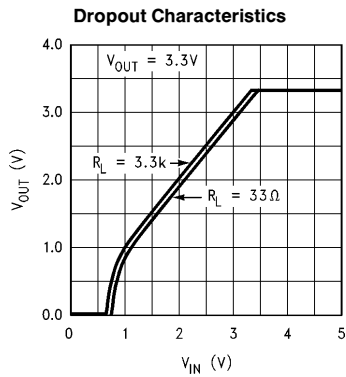

TL/H/12506-10

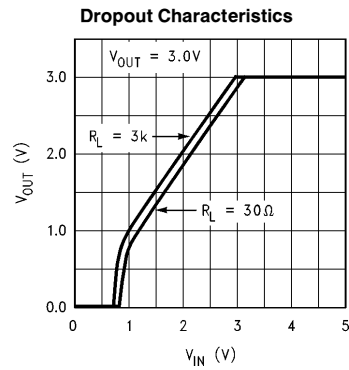

TL/H/12506-11

Typical Performance Characteristics (Continued)

Unless otherwise specified: $T_A = 25^\circ\text{C}$, $V_{IN} = V_{O(NOM)} + 1\text{V}$, $C_{OUT} = 4.7\ \mu\text{F}$, $C_{IN} = 1\ \mu\text{F}$ all voltage options, ON/OFF pin tied to V_{IN} .

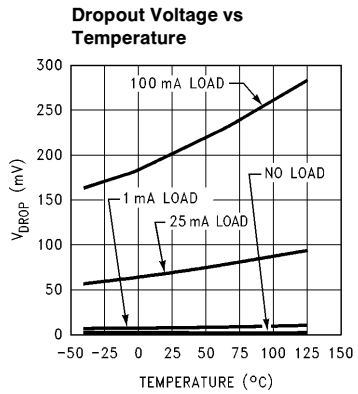

TL/H/12506-12

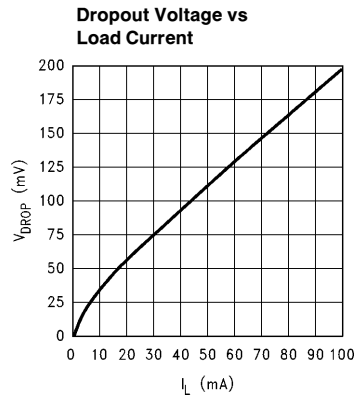

TL/H/12506-13

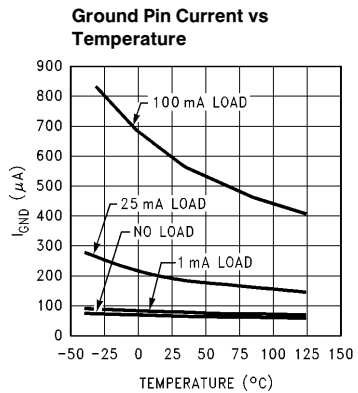

TL/H/12506-14

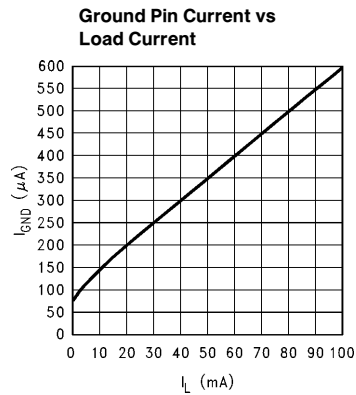

TL/H/12506-15

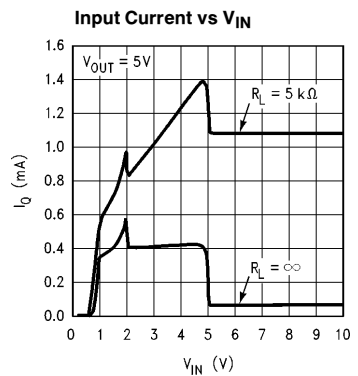

TL/H/12506-16

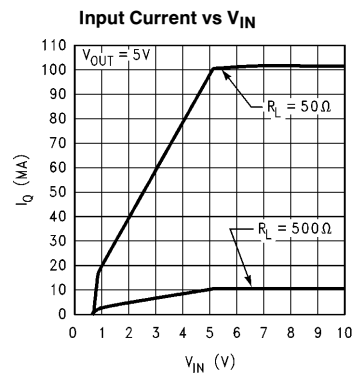

TL/H/12506-17

Typical Performance Characteristics (Continued)

Unless otherwise specified: $T_A = 25^\circ\text{C}$, $V_{IN} = V_{O(NOM)} + 1\text{V}$, $C_{OUT} = 4.7\ \mu\text{F}$, $C_{IN} = 1\ \mu\text{F}$ all voltage options, ON/OFF pin tied to V_{IN} .

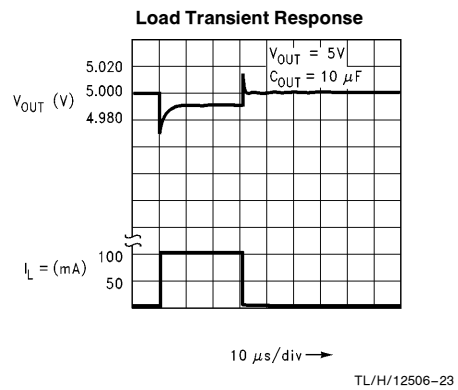
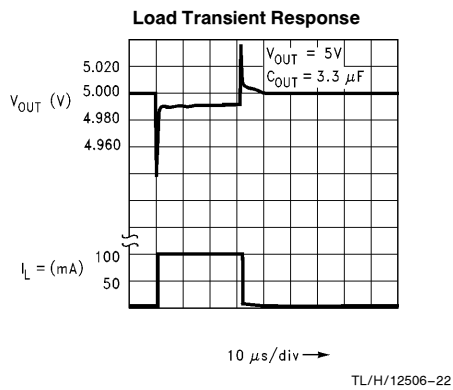
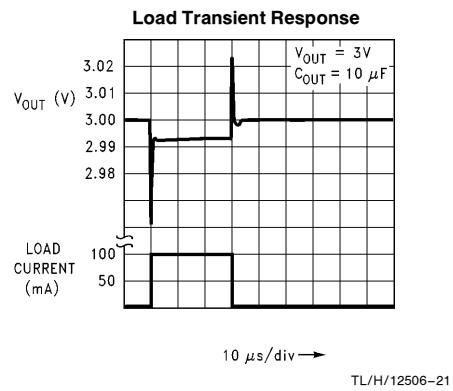
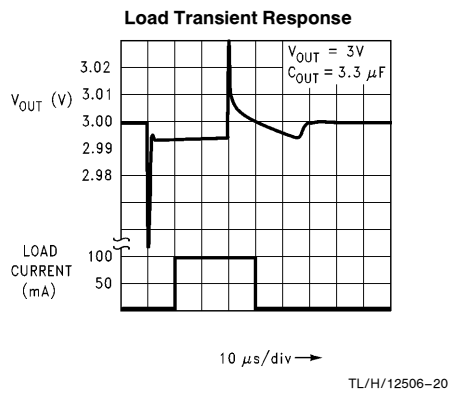
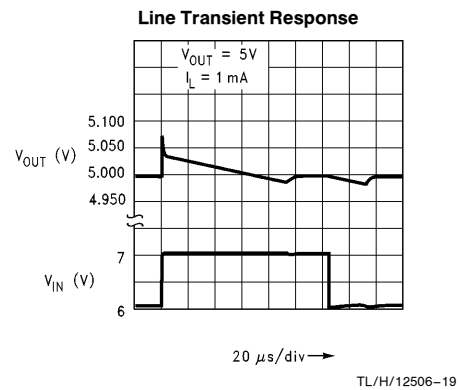
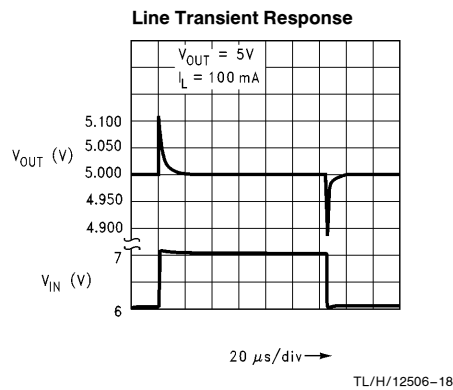

Typical Performance Characteristics (Continued)

Unless otherwise specified: $T_A = 25^\circ\text{C}$, $V_{IN} = V_{O(NOM)} + 1\text{V}$, $C_{OUT} = 4.7\ \mu\text{F}$, $C_{IN} = 1\ \mu\text{F}$ all voltage options, ON/OFF pin tied to V_{IN} .

Short Circuit Current

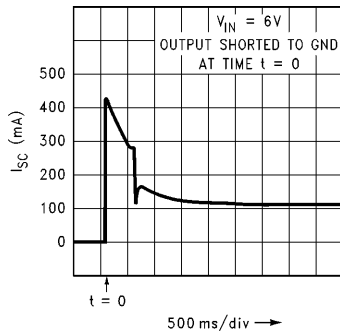

TL/H/12506-24

Instantaneous Short Circuit Current vs Temperature

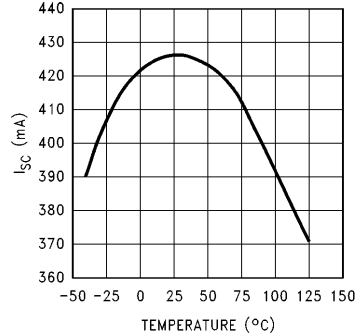

TL/H/12506-25

Short Circuit Current

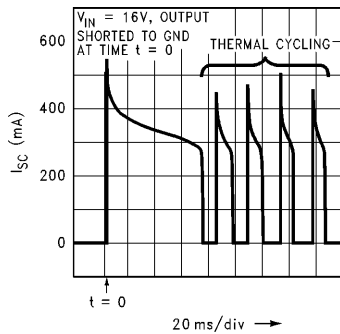

TL/H/12506-26

Instantaneous Short Circuit Current vs Output Voltage

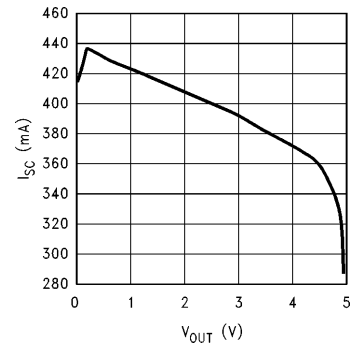

TL/H/12506-27

Output Impedance vs Frequency

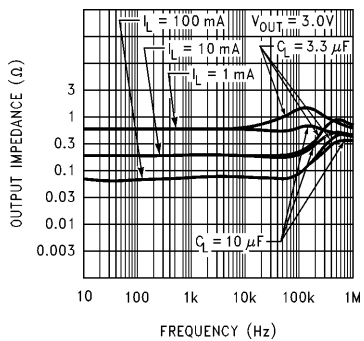

TL/H/12506-28

Ripple Rejection

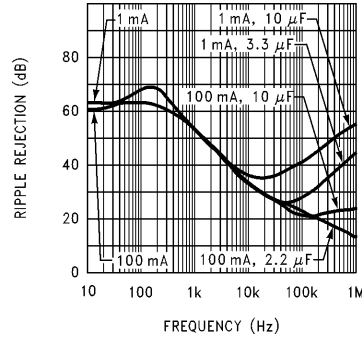

TL/H/12506-29

Typical Performance Characteristics (Continued)

Unless otherwise specified: $T_A = 25^\circ\text{C}$, $V_{IN} = V_{O(NOM)} + 1\text{V}$, $C_{OUT} = 4.7\ \mu\text{F}$, $C_{IN} = 1\ \mu\text{F}$ all voltage options, ON/OFF pin tied to V_{IN} .

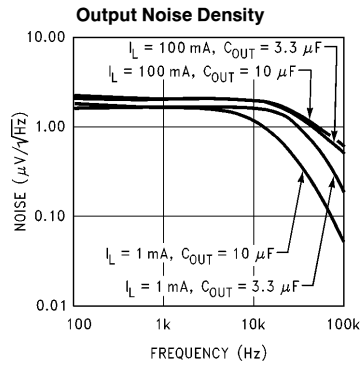

TL/H/12506-30

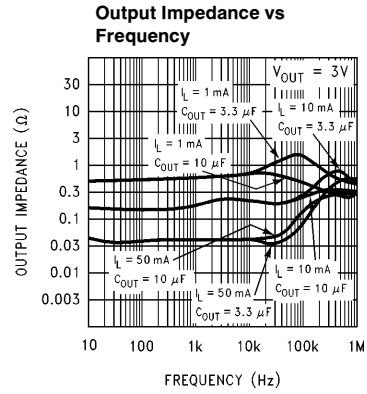

TL/H/12506-31

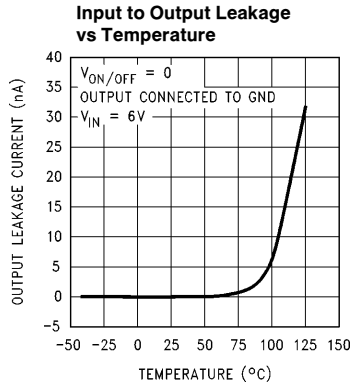

TL/H/12506-32

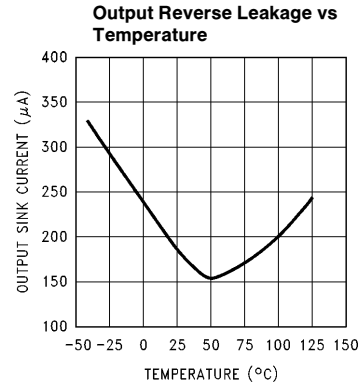

TL/H/12506-33

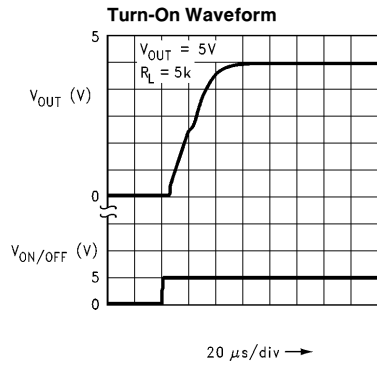

TL/H/12506-34

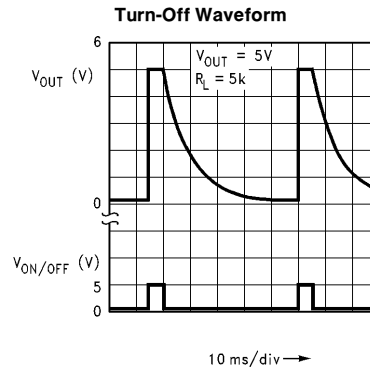

TL/H/12506-35

Typical Performance

Characteristics (Continued)

Unless otherwise specified:

$T_A = 25^\circ\text{C}$, $V_{IN} = V_{O(NOM)} + 1\text{V}$, $C_{OUT} = 4.7 \mu\text{F}$,
 $C_{IN} = 1 \mu\text{F}$, all voltage options, ON/OFF pin tied to V_{IN} .

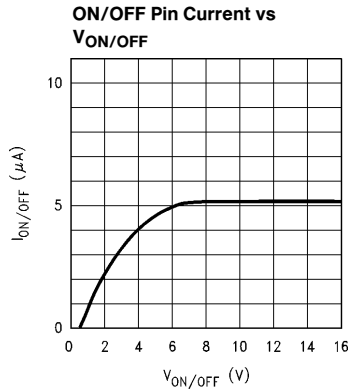

TL/H/12506-36

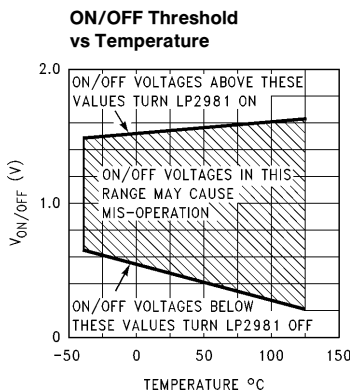

TL/H/12506-37

Application Hints

EXTERNAL CAPACITORS

Like any low-dropout regulator, the external capacitors used with the LP2981 must be carefully selected to assure regulator loop stability.

INPUT CAPACITOR: An input capacitor whose value is $\geq 1 \mu\text{F}$ is required with the LP2981 (amount of capacitance can be increased without limit).

This capacitor must be located a distance of not more than 0.5" from the input pin of the LP2981 and returned to a clean analog ground. Any good quality ceramic or tantalum can be used for this capacitor.

OUTPUT CAPACITOR: The output capacitor must meet both the requirement for minimum amount of capacitance and E.S.R. (equivalent series resistance) value. Curves are provided which show the allowable ESR range as a function of load current for various output voltages and capacitor values (refer to *Figures 1-4*).

IMPORTANT: The output capacitor must maintain its ESR in the stable region over the full operating temperature range to assure stability. Also, capacitor tolerance and variation with temperature must be considered to assure the minimum amount of capacitance is provided at all times.

This capacitor should be located not more than 0.5" from the output pin of the LP2981 and returned to a clean analog ground.

CAPACITOR CHARACTERISTICS

TANTALUM: Tantalum capacitors offer the best value for size, cost, and electrical performance. Most good quality tantalums can be used with the LP2981, but check the manufacturer's data sheet to be sure the ESR is in range.

It is important to remember that ESR increases at lower temperatures and a capacitor that is near the upper limit for stability at room temperature can cause instability when it gets cold.

In applications which must operate at very low temperatures, it may be necessary to parallel the output tantalum capacitor with a ceramic capacitor to prevent the ESR from going up too high (see next section for important information on ceramic capacitors).

CERAMIC: Ceramic capacitors are typically larger and more costly than tantalum for a given capacitance, however they have a much lower ESR (and they do not exhibit the low temperature increase seen in tantalum and aluminum electrolytics).

It should be warned that the ESR of a ceramic can be low enough to go below the minimum stable value for the LP2981. A $2.2 \mu\text{F}$ ceramic was measured and found to have an ESR of about $15 \text{ m}\Omega$, which is low enough to cause oscillations.

This means that in many cases, large value ($\geq 1 \mu\text{F}$) ceramics should not be used on the LP2981 output (the limiting value of ceramic capacitance which can be used will be dictated by the ESR).

If ceramic capacitors are used on the output, they should be used in parallel with a tantalum that provides most of the output capacitance. Remember that when a tantalum and ceramic are put in parallel, the effective ESR seen by the LP2981 output is the parallel value resulting from the ESR of each capacitor.

ALUMINUM: Because of large physical size, aluminum electrolytics are not typically used with the LP2981. They must meet the same ESR requirements over the operating temperature range, more difficult because of their steep increase at cold temperature.

An aluminum electrolytic can exhibit an ESR increase of as much as 50X when going from 20°C to -40°C . Also, some aluminum electrolytics are not operational below -25°C because the electrolyte can freeze.

Application Hints (Continued)

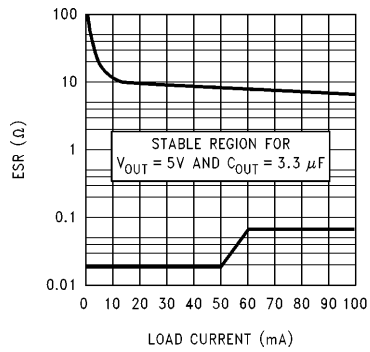

TL/H/12506-38

FIGURE 1. 5V/3.3 μF ESR Curves

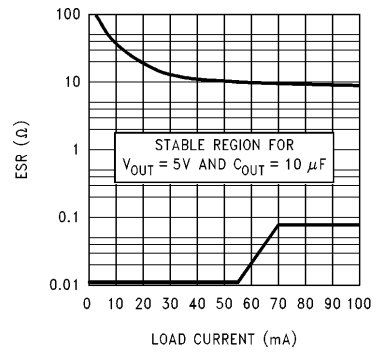

TL/H/12506-39

FIGURE 2. 5V/10 μF ESR Curves

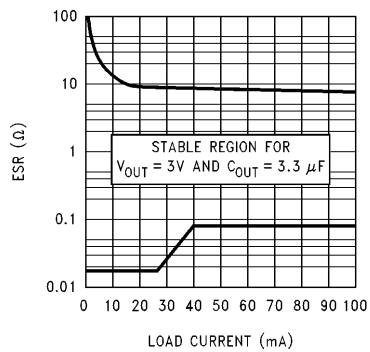

TL/H/12506-40

FIGURE 3. 3V/3.3 μF ESR Curves

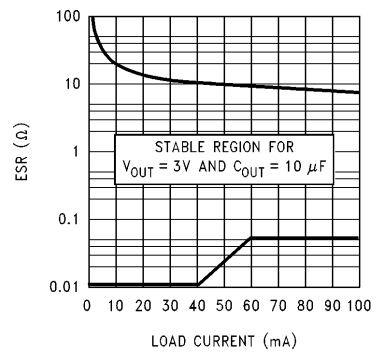

TL/H/12506-42

FIGURE 4. 3V/10 μF ESR Curves

Application Hints (Continued)

REVERSE CURRENT PATH

The power transistor used in the LP2981 has an inherent diode connected between the regulator input and output (see below).

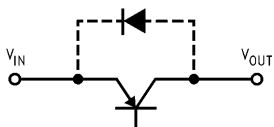

TL/H/12506-41

If the output is forced above the input by more than a V_{BE} , this diode will become forward biased and current will flow from the V_{OUT} terminal to V_{IN} .

This current must be limited to < 100 mA to prevent damage to the part.

The internal diode can also be turned on by abruptly stepping the input voltage to a value below the output voltage.

To prevent regulator mis-operation, a Schottky diode should be used in any application where input/output voltage conditions can cause the internal diode to be turned on (see below).

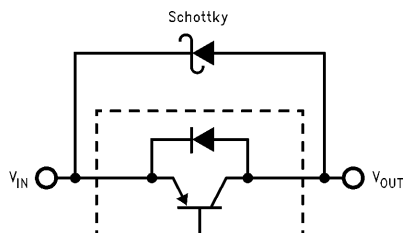

TL/H/12506-43

As shown, the Schottky diode is connected in parallel with the internal parasitic diode and prevents it from being turned on by limiting the voltage drop across it to about 0.3V.

ON/OFF INPUT OPERATION

The LP2981 is shut off by pulling the ON/OFF input low, and turned on by driving the input high. If this feature is not to be used, the ON/OFF input should be tied to V_{IN} to keep the regulator on at all times (the ON/OFF input must **not** be left floating).

To ensure proper operation, the signal source used to drive the ON/OFF input must be able to swing above and below the specified turn-on/turn-off voltage thresholds which guarantee an ON or OFF state (see Electrical Characteristics).

The ON/OFF signal may come from either a totem-pole output, or an open-collector output with pull-up resistor to the LP2981 input voltage or another logic supply. The high-level voltage may exceed the LP2981 input voltage, but must remain within the Absolute Maximum Ratings for the ON/OFF pin.

It is also important that the turn-on/turn-off voltage signals applied to the ON/OFF input have a slew rate which is greater than 40 mV/ μ s.

Important: the regulator shutdown function will operate incorrectly if a slow-moving signal is applied to the ON/OFF input.



Physical Dimensions inches (millimeters) unless otherwise noted

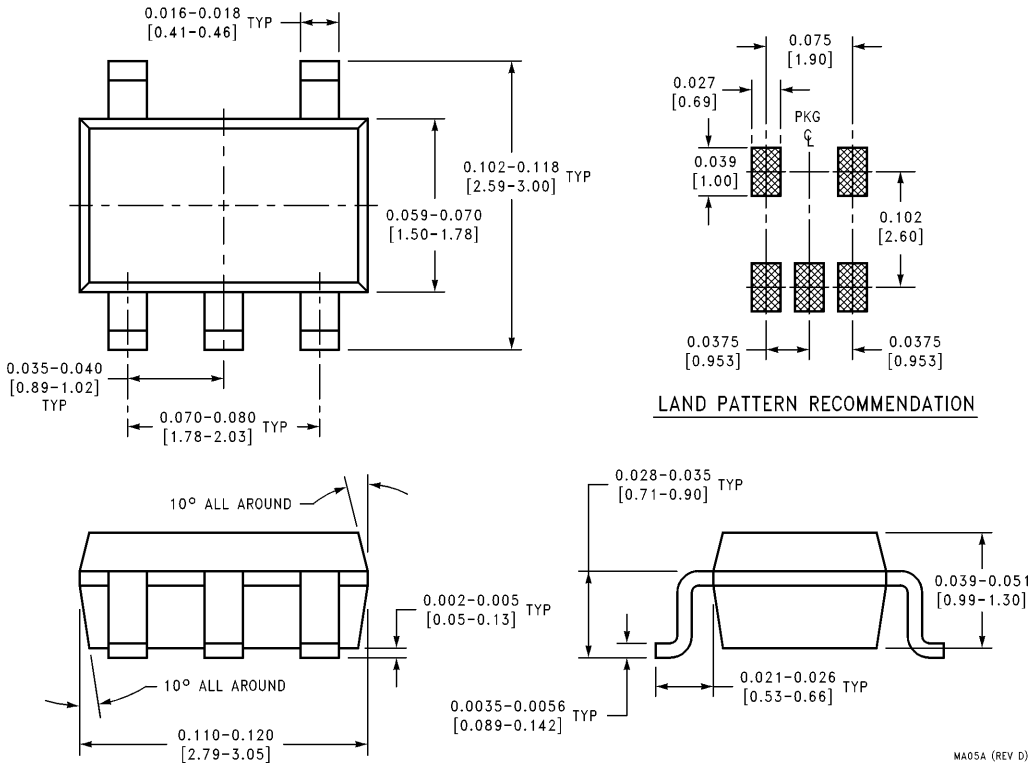

**5-Lead Small Outline Package (M5)
NS Package Number MA05A**

For Order Numbers, refer to Table I in the "Order Information" section of this document.

LIFE SUPPORT POLICY

NATIONAL'S PRODUCTS ARE NOT AUTHORIZED FOR USE AS CRITICAL COMPONENTS IN LIFE SUPPORT DEVICES OR SYSTEMS WITHOUT THE EXPRESS WRITTEN APPROVAL OF THE PRESIDENT OF NATIONAL SEMICONDUCTOR CORPORATION. As used herein:

1. Life support devices or systems are devices or systems which, (a) are intended for surgical implant into the body, or (b) support or sustain life, and whose failure to perform, when properly used in accordance with instructions for use provided in the labeling, can be reasonably expected to result in a significant injury to the user.
2. A critical component is any component of a life support device or system whose failure to perform can be reasonably expected to cause the failure of the life support device or system, or to affect its safety or effectiveness.



National Semiconductor Corporation
1111 West Bardin Road
Arlington, TX 76017
Tel: (800) 272-9959
Fax: (1800) 737-7018

<http://www.national.com>

National Semiconductor Europe

Fax: +49 (0) 180-530 85 86
Email: europe.support@nsc.com
Deutsch Tel: +49 (0) 180-530 85 85
English Tel: +49 (0) 180-532 78 32
Français Tel: +49 (0) 180-532 93 58
Italiano Tel: +49 (0) 180-534 16 80

National Semiconductor Hong Kong Ltd.

19th Floor, Straight Block,
Ocean Centre, 5 Canton Rd.
Tsimshatsui, Kowloon
Hong Kong
Tel: (852) 2737-1600
Fax: (852) 2736-9960

National Semiconductor Japan Ltd.

Tel: 81-043-299-2308
Fax: 81-043-299-2408

This datasheet has been download from:

www.datasheetcatalog.com

Datasheets for electronics components.